

Varenummer: 0106062
 Beskrivelse: Seeger låsering JV 45

Mål

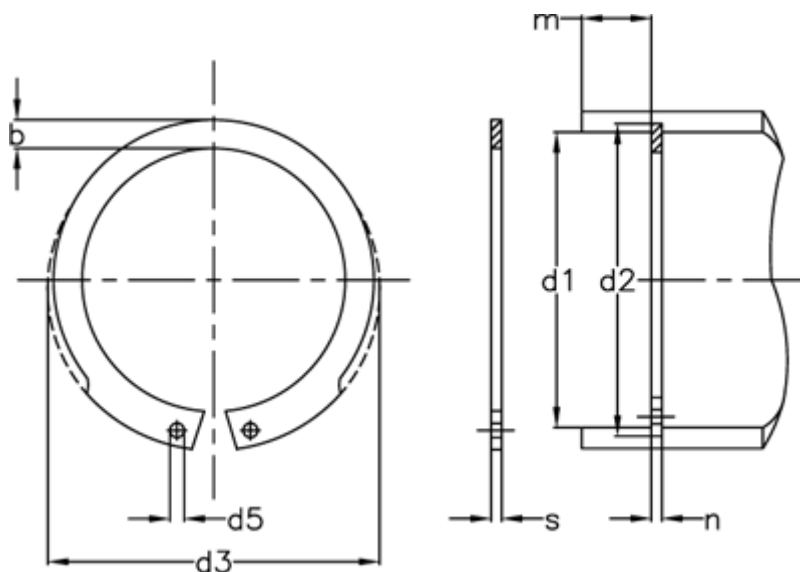

AN mm ²	= 90	FRg kN	= 8.4	Tang	= ZGJ-2
b	= 4.2	FR kN	= 44.0	tol	= -0.06
Betegnelse	= JV 45	g	= 2.0	tol	= +0,90-0,39
d1	= 45	K kN-mm	= 79.5	tol	= +0,25
d2	= 47.5	m min	= 1.85	tol	= 0.2
d3	= 48.5	Nominel træk	= 3.8	vægt kg/1000	= 6.00
d5 min	= 2.0	s	= 1.75		
FN kN	= 15.00	t	= 1.25		